

K MACHINE



non-toxic



economical



eco-friendly



quality



 **PODhead[®]**
MACHINES

EN User Manual
E.S.E. Single-Serve Espresso
& Coffee POD Brewer

USER MANUAL

INDEX

E.S.E Single-Serve Espresso Coffee POD Brewer



1. IMPORTANT SAFETY PRECAUTIONS.....	3-5
2. TECHNICAL INFORMATION.....	6
3. GETTING TO KNOW YOUR COFFEE MACHINE.....	7
4. USING YOUR COFFEE MACHINE.....	8-10
5. PERSONALIZING YOUR COFFEE MACHINE.....	11
6. RESETTING YOUR COFFEE MACHINE	12
7. MAINTAINING YOUR COFFEE MACHINE.....	12
8. TROUBLESHOOTING.....	13
9. WARRANTY.....	14-15

ENJOY AN EXCEPTIONAL ESPRESSO EXPERIENCE

Please read all instructions carefully before installing or using your appliance for the first time. Keep this manual for future reference.

1. IMPORTANT SAFETY PRECAUTIONS

General Safety

- This appliance is intended exclusively for preparing espresso coffee beverages as described in this manual.
- Do not use the appliance for any purpose other than its intended use.
- This appliance is designed for indoor use only and for non-extreme temperature conditions.
- Protect the appliance from direct sunlight, prolonged water exposure, and excessive humidity.
- This appliance may be used by children aged 8 years and older, provided they are supervised or instructed on safe use and understand the associated hazards. Cleaning and maintenance must not be performed by children unless they are over 8 years old and supervised. Keep the appliance and power cord out of reach of children under 8 years of age.
- The appliance may be used by people with reduced physical, sensory, or mental capabilities, or lack of experience and knowledge, provided they are supervised or instructed on safe use and understand the hazards involved.
- Children must not play with the appliance.
- The manufacturer accepts no responsibility, and the warranty will not apply for commercial use, improper handling, use for unintended purposes, faulty operation, non-authorized repairs, or failure to comply with these instructions.

Avoid Risk of Electric Shock and Fire

- In case of emergency, immediately unplug the appliance from the power outlet.
- Only connect the appliance to a suitable, easily accessible, properly grounded power outlet. Ensure that the mains voltage matches the rating plate specifications. Incorrect connections void the warranty.

1. IMPORTANT SAFETY PRECAUTIONS

- The appliance must only be connected to the power supply after installation.
- Do not pull the power cord over sharp edges, clamp it, or allow it to hang freely.
- Keep the power cord away from heat and moisture.
- If the power cord is damaged, it must be replaced by the manufacturer, its service agent, or similarly qualified personnel to avoid hazards.
- Do not operate the appliance if the power cord is damaged.
- If an extension cord is required, use only a grounded extension cord with a conductor cross-section suitable for the appliance's power rating.
- Never place the appliance on or near hot surfaces such as radiators, stoves, ovens, gas burners, open flames, or similar heat sources.

Safe Operation

- Always place the appliance on a stable, level, and heat-resistant surface. The surface must be resistant to water, coffee, and similar liquids.
- Disconnect the appliance from the power supply when not in use for extended periods.
- Always unplug the appliance by pulling the plug, not the cord.
- Before cleaning or maintenance, unplug the appliance and allow it to cool completely.
- Never touch the power cord with wet hands.
- Never immerse the appliance or any part of it in water or other liquids.
- Never place the appliance or any of its parts in a dishwasher.
- Water and electricity together are dangerous and can cause fatal electric shock.
- Do not open the appliance. Hazardous voltage is present inside.
- Do not insert any objects into openings. This may cause fire or electric shock.

1. IMPORTANT SAFETY PRECAUTIONS

Avoid Injury During Use

- Never leave the appliance unattended during operation.
- Do not use the appliance if it is damaged or malfunctioning. Immediately unplug it and contact an authorized service representative.
- A damaged appliance may cause electric shock, burns, or fire.
- Always fully close the operating lever before extraction and never open it during operation. Risk of scalding.
- Do not place fingers under the coffee extraction outlet. Risk of scalding.
- Do not insert fingers into the pod compartment. Risk of injury.
- Never use damaged or deformed E.S.E. pods. If a pod becomes stuck, turn off and unplug the appliance before attempting removal. Contact an authorized service representative if necessary.
- Fill the water tank only with fresh, potable water.
- Empty the water tank if the appliance is not used for an extended period.
- Replace the water in the tank if the appliance has not been used for several days.
- Always use the drip tray and drip grid to prevent liquid from spilling onto surrounding surfaces.
- Use only soft, damp cloth and mild detergent for cleaning. Do not use abrasive cleaners or solvents.
- The manufacturer reserves the right to modify these instructions without prior notice.

2. TECHNICAL INFORMATION



- Professional 20 Bar pump
- Removable 1.2 L water tank (40.6 fl oz / 1.27 qt)
- Italian-Style Pre-Infusion Technology
- Manual temperature adjustment on 4 levels (198–208°F | 92–98°C)
- Programmable brew time: 10-120 seconds
- Automatic pod ejection (collector holds approx. 10 pods)
- Dimensions (L×W×H): 348 × 109 × 223 mm (13.7 × 4.3 × 8.8 in)
- Weight: Approx. 2.7 kg (6.0 lb)
- Power: 1350 W • Voltage: 110–120 V~, 60 Hz
- Warranty: 2 years

3. GETTING TO KNOW YOUR COFFEE MACHINE

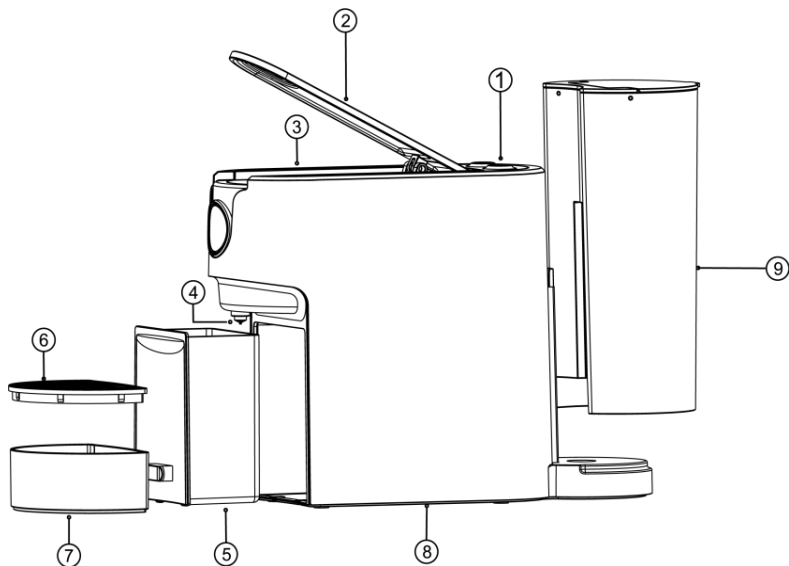

Machine Components

- | | |
|------------------------------|-------------------------|
| 1. Coffee buttons | 6. Espresso cup tray |
| 2. Operating lever | 7. Removable drip tray |
| 3. E.S.E. pod compartment | 8. Machine body |
| 4. Coffee extraction outlet | 9. Removable water tank |
| 5. Used E.S.E. pod container | |

Control Panel

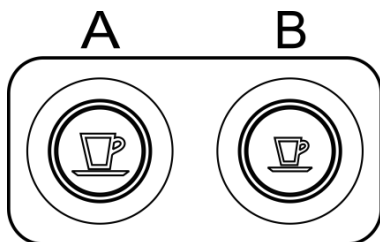

- A. Lungo coffee button
B. Espresso coffee button

4. USING YOUR COFFEE MACHINE

First-Time Use

Ensure all accessories are present and the appliance is not damaged.

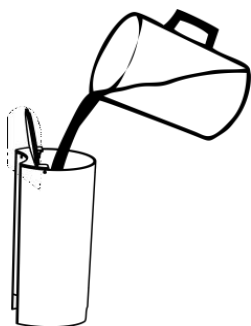

Rinse the water tank and fill it with fresh, potable water.

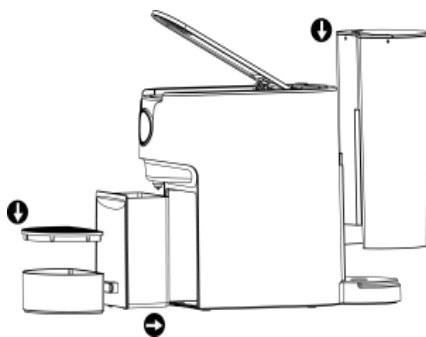

Install the water tank, drip tray, and used pod container correctly.

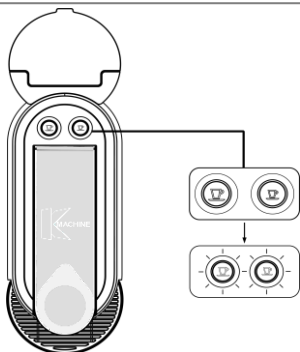

Plug the appliance into the power outlet. Both buttons will flash three times.

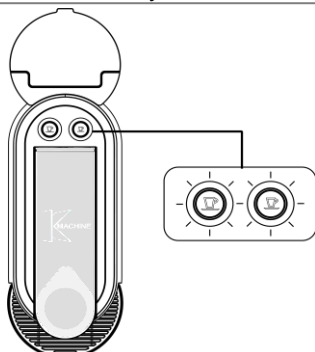

Press any button to start heating. The lights will blink for approximately 20–35 seconds.

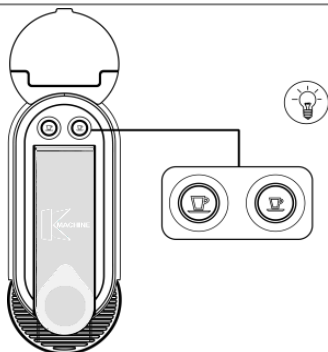

When the lights remain steady, the machine is ready for use.

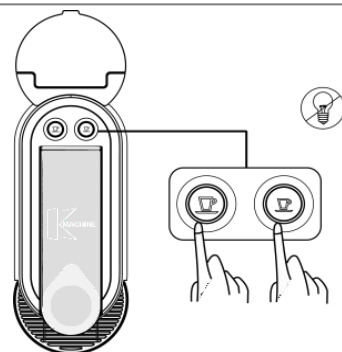

Press and hold both buttons simultaneously to turn OFF the machine

4. USING YOUR COFFEE MACHINE

Note: Before making coffee, rinse the machine by placing a container under the extraction outlet. Do not insert a pod. Close the operating lever and press any button. Repeat this process three times.

Coffee Extraction



Place an espresso cup on the drip tray

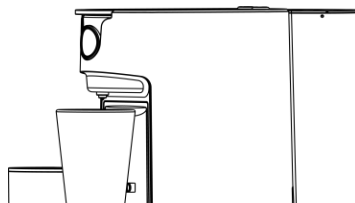

Or remove the drip tray for taller cups

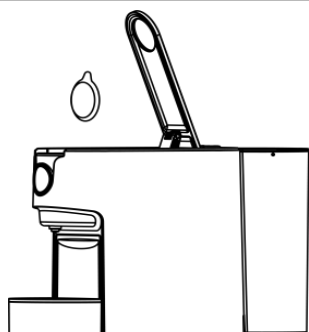

Open the operating lever and insert a E.S.E. pod and close the lever securely

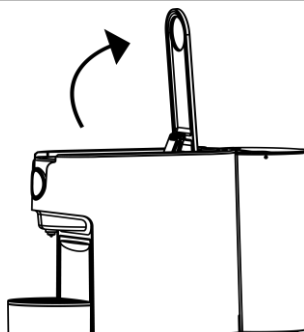

After extraction, open the lever. The used pod will be automatically ejected into the used pod container

How to Insert E.S.E. Espresso Pod

- Let the E.S.E. pod fall gently into the pod slot, ensuring it is centered and fully seated before closing the lever.
- Pods vary slightly by brand, so adjust placement as needed to ensure proper fit.



4. USING YOUR COFFEE MACHINE

Press **Lungo** or **Espresso** button.

Extraction will begin, and the selected button light will blink.

Factory Settings:

Lungo: 45 ± 7 ml

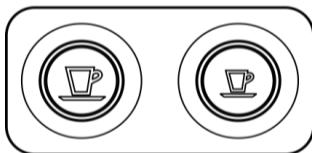

Espresso: 25 ± 5 ml

Extraction stops automatically or press the button again to stop manually

Energy-Saving Mode

- The machine automatically switches off after 30 minutes of inactivity. All indicator lights turn off.
- Press any coffee button to exit standby mode. The machine will heat up and be ready for use within approximately 20–35 seconds

Alerts and Alarms

NTC Malfunction:

If both coffee buttons blink alternately, turn off the appliance, wait 2 minutes, and restart it. If the issue persists, contact an authorized service representative.

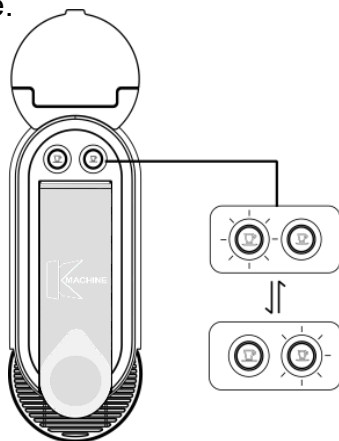

5. PERSONALIZING YOUR COFFEE MACHINE

Customized Coffee Volume

- Ensure the water tank is filled and the machine is ready for use.
- Press and hold the desired coffee button for 3 seconds until extraction begins, then release.
- Press the same button again when the desired volume is reached.
- The machine will save this setting for future use.

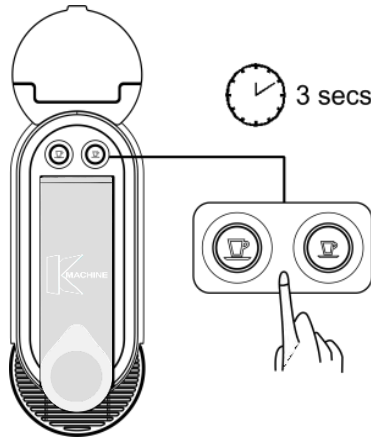

Customized Temperature

The machine offers four temperature levels:

- Level 4: $98 \pm 5 \text{ }^\circ\text{C}$ → $208 \pm 9 \text{ }^\circ\text{F}$ (4 Blinks)
- Default** ○ Level 3: $96 \pm 5 \text{ }^\circ\text{C}$ → $205 \pm 9 \text{ }^\circ\text{F}$ (3 Blinks)
- Level 2: $94 \pm 5 \text{ }^\circ\text{C}$ → $201 \pm 9 \text{ }^\circ\text{F}$ (2 Blinks)
- Level 1: $92 \pm 5 \text{ }^\circ\text{C}$ → $198 \pm 9 \text{ }^\circ\text{F}$ (1 Blink)

To adjust temperature:

- Plug in the appliance. Both buttons will flash three times.
- After flashing stops, press and hold any button until the lights flash again to enter temperature setting mode.
- Press the **Lungo** button to **increase** the temperature level.
- Press the **Espresso** button to **decrease** the temperature level.
- After 5 seconds of inactivity, the setting is saved automatically

6. RESETTING YOUR COFFEE MACHINE

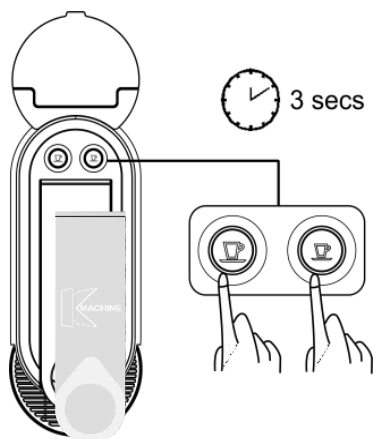

- Ensure the machine is OFF and unplugged.
- Plug the machine back in.
- While the buttons flash three times, press both buttons simultaneously to restore factory settings.

7. MAINTAINING YOUR COFFEE MACHINE

Warning: Always unplug the appliance and allow it to cool before cleaning or maintenance.

After brewing, lift the lever to release the used pod into the used pod container (capacity: approximately 10 pods).

Clean the machine weekly:

Close the lever without inserting a pod, place a cup on the drip tray, and press the large cup button to run a rinse cycle.

General Care:

- Empty the drip tray and used pod container regularly.
- Clean the extraction outlet and machine surfaces regularly with a soft, damp cloth.
- Never immerse the appliance in water.
- Do not use abrasive cleaners, solvents, or dishwashers.
- To maintain optimal performance, descale the machine every three months or after approximately 200 extractions.

TROUBLESHOOTING

If the machine is not working properly make the simple checks set out below:

PROBLEM	POSSIBLE CAUSE	POSSIBLE SOLUTION
Machine does not start.	Not properly plugged into the power socket.	Make sure it is properly plugged in.
The coffee is too cold.	The temperature is not adjusted.	Customize the desired temperature (page 11)
Coffee will not brew.	Not enough water in the tank OR Used Pod Collector Drawer is full.	Make sure that there is enough water in the tank OR empty the Used Pod Collector Drawer.
Coffee is brewing too slowly.	Coffee in the pod is ground too finely.	Adjust the brewing time or press the brew button again to continue brewing.
Pod is stuck in the Pod Drop Slot.	Pod was not ejected after last use OR the Used Pod Collector Drawer is full.	Eject Pod after each use. Empty the Used Pod Collector Drawer. If pod is stuck, use tweezers to pull the pod out from the top.
Pod Drop Slide Lever does not shut	The coffee or espresso pod is the incorrect size, the previous used pod is still in the Drop Slot OR the Used Pod Collector Drawer is full.	Use only 44mm coffee and espresso pods, clear the Drop Slot OR empty the Used Pod Collector Drawer.
Water is appearing on the counter around the base of the brewer.	The Coffee Cup Drip Tray or the Tray under the Used Pod Collector Drawer needs to be emptied and cleaned.	Empty the liquid contents collected in the Coffee Cup Drip Tray or the Tray under the Used Pod Collector Drawer.

If the problem is not listed or if it persists, even if you follow the advice given, visit www.podhead.com for technical support or contact customer service.

REPLACEMENT PARTS

All removable parts can be ordered by contacting customer service at www.podhead.com

Do not throw away the brewer with the normal household waste at the end of its life, but hand it in at an official collection point for recycling. By doing so, you help to preserve the environment.

LIMITED WARRANTY

Warranty Coverage: This product is warranted to be free from defects in materials or workmanship under normal use for a period of (2) years from the original purchase date. This product warranty is extended only to the original consumer purchaser of the product and is not transferable. For a period of two (2) years from the date of original purchase of the product, our Repair Center will, at its option, either (1) repair the product or (2) replace the product with a reconditioned comparable model. These remedies are the purchaser's exclusive remedies under this warranty.

Warranty Service: To Obtain warranty service, you must call our warranty service number at (401) 409-4076 for return instructions on how to deliver the product, in either the original packaging or packaging affording an equal degree of protection to the Repair Center specified below. You must enclose a copy of your sales receipt or other proof of purchase to demonstrate eligibility for warranty coverage.

To return the appliance, ship to:

PODhead / K MACHINE
Attn: Repair Center
P.O.BOX 5477
Wakefield, RI 02880 - USA

To contact us, please email us at contact@podhead.com

What is not covered: This warranty does not cover damage resulting from misuse, accident, commercial use, improper service or any other damage caused by anything other than defects in material or workmanship during ordinary consumer use. This warranty is invalid if the serial number has been altered or removed from the product. This warranty is only valid in the United States, Canada and Europe.

LIMITATION ON DAMAGES: THERE SHALL BE NO LIABILITY FOR ANY INCIDENTAL OR CONSEQUENTIAL DAMAGES FOR BREACH OF ANY EXPRESS OR IMPLIED WARRANTY OR CONDITION ON THIS PRODUCT.

DURATION IF IMPLIED WARRANTIES: EXCEPT TO THE EXTENT PROHIBITED BY APPLICABLE LAW, ALL IMPLIED WARRANTIES AND CONDITIONS, INCLUDING, WITHOUT LIMITATION, IMPLIED WARRANTIES AND CONDITIONS OF MERCHANTABILITY AND FITNESS FOR A PARTICULAR PURPOSE OR USE ON THIS PRODUCT ARE LIMITED IN DURATION TO THE DURATION OF THIS WARRANTY.

Some jurisdictions do not allow the exclusion or limitation of incidental or consequential damages or allow limitations on how long an implied warranty lasts, so the above limitations or exclusions may not apply to you. This warranty gives you specific legal rights and you may have other rights under the laws of your jurisdiction.

AUTHORIZED SERVICE

For Service Information Contact:

PODhead.com
1-401-409-4076

SERVICE CENTER LOCATION

PODhead / K MACHINE
Attn: Repair Center
P.O.BOX 5477
Wakefield, RI 02880 - USA

RECORD MODEL & SERIAL NUMBER

In order to receive accurate and timely warranty assistance, it is important to record the Model and Serial Number information located on the bottom of the brewer.

Model: _____

Serial Number: _____

Record these numbers from the bottom of the brewer, before filling the brewer with water.

THANK YOU FOR YOUR PURCHASE

PODhead[®].com

PODhead.com, LLC
USA
www.podhead.com



© 2026 PODhead.com

